

GramLine

No.1 FOR STEEL PRIVACY FENCING



STEEL PRIVACY FENCING INSTALLATION GUIDE



STEP-BY-STEP INSTALLATION

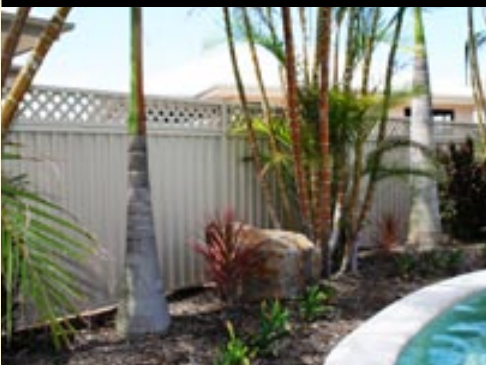

Thank You for purchasing your NEW GramLine Steel Privacy Fence. This guide will help guide you through the installation process.

BEFORE YOU START

- First thing that you need to do when getting ready to install a fence is to make sure where your property boundary line actually is.
- You and your neighbour need to clearly determine and pin-point your properties boundary line, where the fence will be installed and mark the position using a temporary string line. In some cases a surveyor may be required.
- Determine if your land level is different to your neighbours. If so, GramLine Plinths may be needed to maintain existing levels.
- GramLine Plinths can also be used to fill in the gaps under your NEW GramLine Fence.
- If you intend on installing your fence above 1800mm high check council regulations for boundary fence heights, also seek advice from GramLine.
- Decide if your fence will be sloped or stepped. For a more attractive and stronger result sloping is highly recommended on sloped or uneven ground.
- You need to identify the soil type for your fence site. This will determine the hole size, depth and the amount of concrete that is required for the job.
- Check that you have the correct number of components for the job. Make sure that you also check the condition of the material.
- Ensure you read and understand this guide completely before you begin.
- If you are in doubt about installing a GramLine Fence yourself seek advice from your nearest supplier.



BEFORE

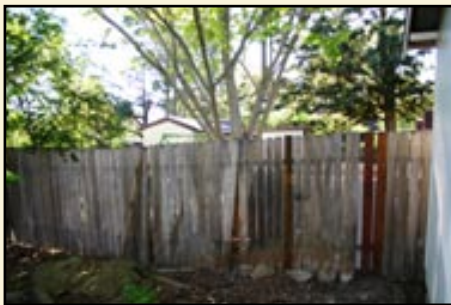

AFTER



WARNING

You need to know the whereabouts of underground services, electricity, gas and water mains before you begin digging.
Call 1100 "Dial Before You Dig".

SITE DETAILS

Steel Privacy Fencing made from Pre-painted Hi-Tensile Steel is designed to withstand most wind conditions. The wind on the fence at your site will depend on a number of factors including where you live and the number of surrounding properties.

THESE DETAILS WILL HELP YOUR GRAMLIN SUPPLIER TAILOR A DESIGN THAT IS BEST SUITED FOR YOU.

- If in proximity to severe marine conditions or swimming pools splash zone please seek advice from GramLine.
- If you live in any other regions except REGION A, please contact GramLine to discuss your Steel Privacy Fencing requirements.

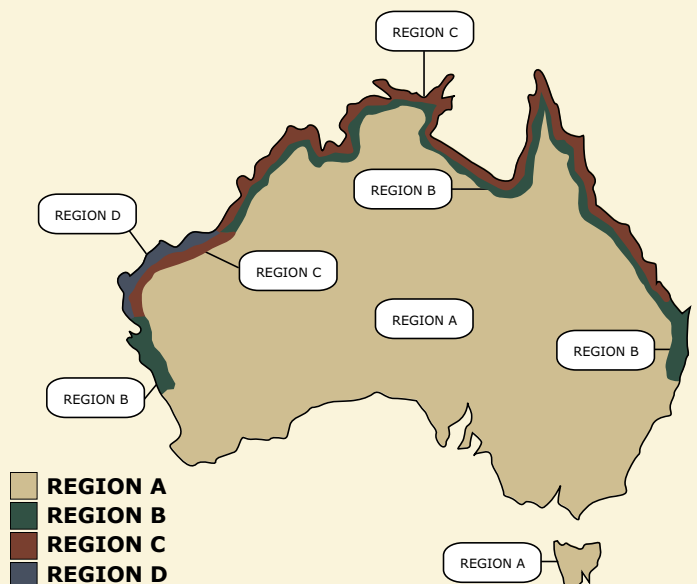

EQUIPMENT REQUIREMENTS

Tools

- Self-drilling screw gun with clutch system (electrical or battery operated).
- Spirit Level or Magnetic Level.
- Rubber Mallet.
- String Line & Marker Pegs.
- Post Hole Scissor Shovel.
- Wheelbarrow and Larry Hoe.
- Spud Bar.
- Earth Leakage Circuit Breaker.
- Petrol Post Hole Digger.
- Magnetic Hex Driver.

Personal Protective Equipment

- Safety Glasses.
 - Protective Gloves.
 - Hat & Sun lotion for skin protection.
 - Appropriate safety footwear.
 - Ear Muffs (if cutting required).
- Most pieces of equipment are available for hire at tool hire centres

Optional Equipment

- Nibbler (if cutting required).
- Tin Snips (if cutting required).
- Concrete Mixer.



DURING INSTALLATION

- Always use protective equipment when operating tools.
- Always start and end a GramLine Fence run with a 50sq post (do not use only a single Channel Post).



- Make sure that you clean and remove any excess concrete off your fence post immediately. If left to dry, it will permanently mark your fence.

- If your GramLine sheets need to be cut, only use cold cutting tools, such as a nibbler or tin snips (do not use angle grinders or hot cutting saws).

- Touch up paint should not be used to repair any scratches, as the paint fades differently. Small scratches are best left alone. If the damage is severe then it is best to replace the damaged section of the fence.

BRANDING



- For Peace of Mind always ensure that your product is branded with the GramLine brand, if not, send it back.

- All our GramLine Rails and Lattice are embossed with the GramLine brand.

- GramLine Posts, Rails and Infill sheets are inkjet branded for full traceability.

- Buying the GramLine branded product range ensures you are buying quality.

FENCE DETAILS

SLOPED



STEPPED



TAPERED



Sloping gives you a better overall appearance, and it doesn't leave you with unsightly gaps under your fence.

We recommend that you taper the last panel where possible as this improves the structural integrity of the fence.

STEP 1: MARKING OUT YOUR POST HOLES

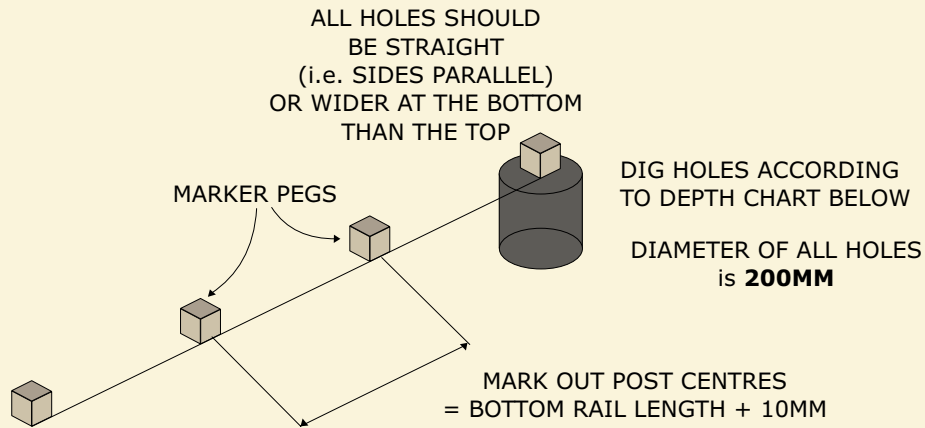

IMPORTANT: Post lengths will increase accordingly to cater for these ground conditions.

SOIL TYPE	MINIMUM HOLE DEPTH	APPROX. CONCRETE REQUIRED
Rock	300mm	1 Bag per hole (20kg bag)
Clay / Firm Earth	600mm	2 Bags per hole (20kg bag)
Sand / Loose Fill	900mm	3 Bags per hole (20kg bag)

SLOPING OR UNEVEN SITES

ADDITIONAL INFORMATION

It is recommended that you invest a small amount of extra effort to slope your fence on sloping or uneven ground rather than stepping the panels. It achieves a better overall appearance as well as providing a stronger fence.

A) MARKING OUT SLOPING SITES

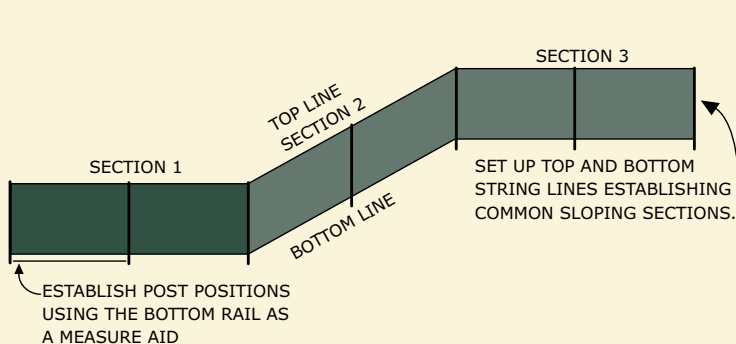

Sheets may need to be cut if the slope is greater than 1 in 8, and at the end of any non standard panel length. A nibbler or cold cutting saw should be used, not a angle grinder.



B) CUTTING SHEETS FOR A SLOPED FENCE

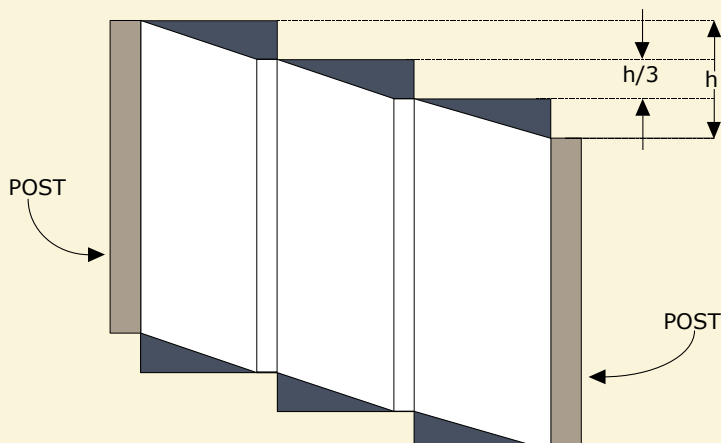

The preferred method of cutting sheets is to use a nibbler or tin snips. (Never burn the steel always cold cut) See warranty.



STEP 2: SECURING THE POSTS

A) FASTENING POSTS TOGETHER

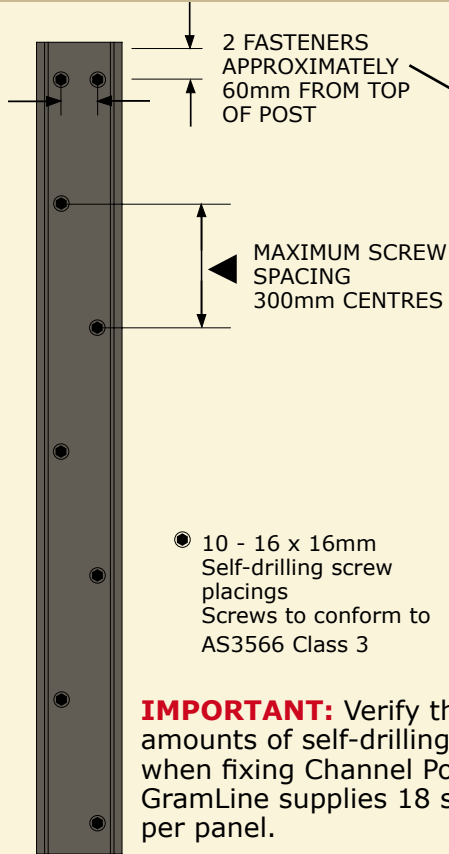

IMPORTANT: Verify that the correct amounts of self-drilling screws are used when fixing Channel Posts together. GramLine supplies 18 self-drilling screws per panel.

FIXING POSTS IN THE GROUND

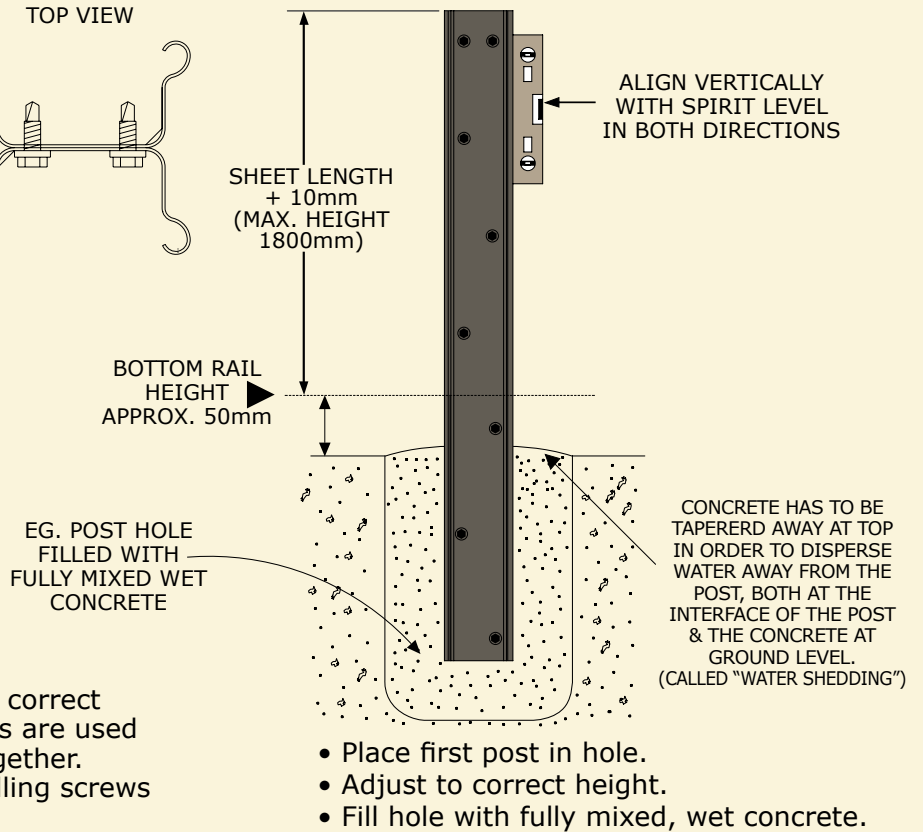

END POSTS, CORNER POST & JUNCTIONS

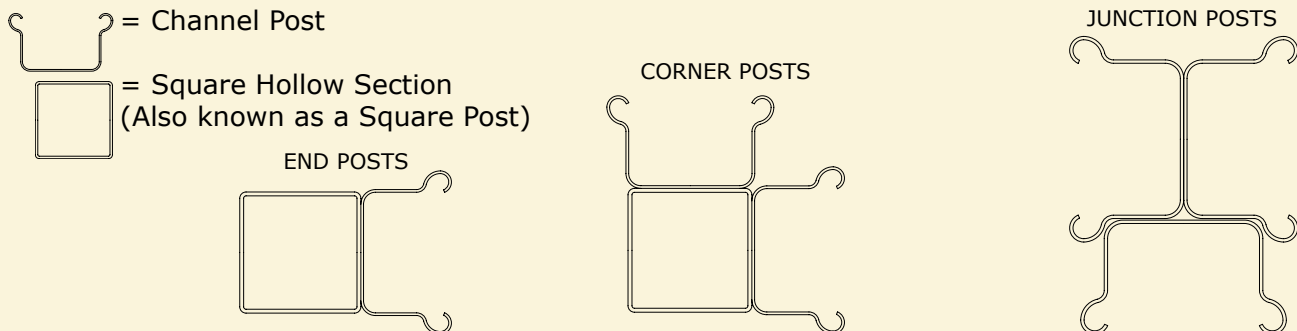

TAPERING THE FRONT OF YOUR FENCE

It is highly recommended that you taper the last panel of your fence. Particularly where your fence extends beyond the front of your house. Cut sheets as per the instructions in the "sloping or uneven sites" section.

The minimal extra effect in tapering the last panel will provide a better looking fence than a stepped fence and is stronger than leaving it at full height.



REMEMBER THAT THE LEADING POST AT THE FREE END SHOULD INCLUDE A SQUARE HOLLOW SECTION (i.e. SHS)

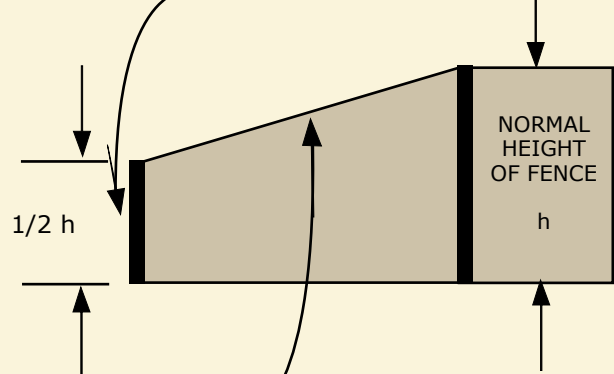

NOTE: A LONGER TOP RAIL WILL BE REQUIRED FOR THE TAPERED PANELS

STEP 3: INSTALLING FENCE PANELS

INSTALLING FRAME

INSTALLING SHEETS

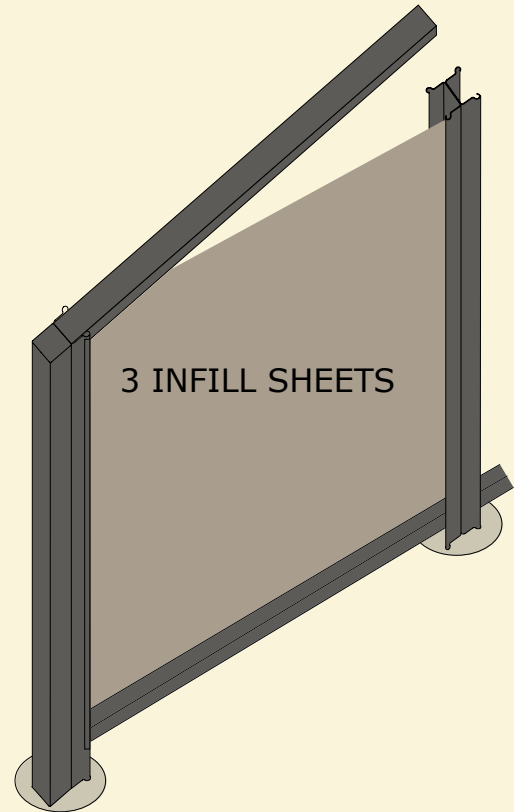
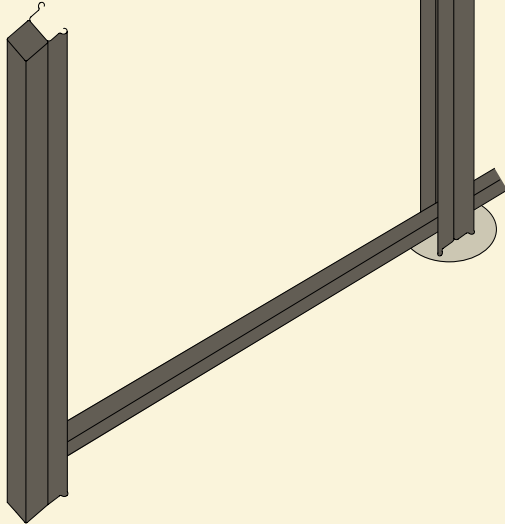
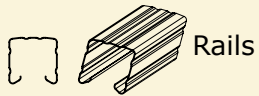

- Insert bottom rail between posts to determine exact locations of next post.
- Adjust bottom rail to correct height - it is important to maintain a minimum gap of 50mm between bottom of rail and ground. (If you are not installing a GramLine Plinth).
- Fix the rail with self-drilling screws at this stage.
- Place top rail into post and fix with self drilling screws on both sides of posts. Ensure that the self drilling screws are not fully tightened, as they need to be removed when inserting sheets. Ensure the position of the top rail is protruding 2mm above the top of the posts to reduce the risk of injury.
- Continue this procedure until fence length is achieved.
- Check installation and alignment of posts.
- Allow the concrete to cure overnight.
Note: A longer curing period may be required in cold and/or wet weather.



- Unscrew one end of the top rail.
- Fit infill sheets into bottom rail ensuring correct overlap as per diagram below.

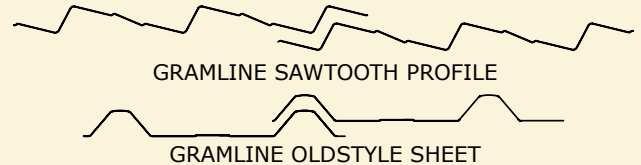

CORRECT OVERLAP DETAIL FOR THE INFILL SHEET PROFILES

- Place top rail on infill sheets working from one end to the other, locating the sheet in the rail. A gentle tap with a rubber mallet may help.
- Secure the top rail with self drilling screws.
- Hose down your fence when finished to remove any swarf such as drill filings or remnants from the nibbling process. Failure to remove any swarf, will result in rust spots.



MORE INSTALLATION TIPS

LATTICE

- Always handle Lattice with care, when manually handling, always carry vertically.
- If cutting is required always wear safety glasses.
- A cold cutting saw should be used. Clamp the material well to prevent vibrating and damage to the joins.



1. Slide bottom rail into channel post, and fix to the channel post with self drilling screws.
2. Slide Lattice into the bottom rail, handle gently.
3. Install the top rail on top of the lattice. Fix the top rail to the channel posts with the self-drilling screws.

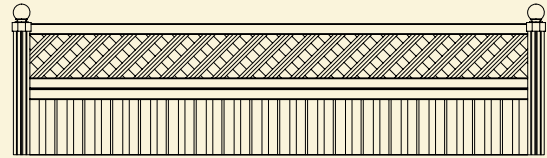

PLINTH

1. Concrete in your first Channel Post.
2. Slide the GramLine Plinth into your Channel Post.
3. Install your next Channel Post.
4. Install the bottom Rail to the required position and screw the Rail and the Plinth to the Channel Post, and continue to install the GramLine Steel Privacy Fencing in the normal fashion.
5. When you are installing more than one GramLine Plinth, lay the Plinths on the ground and stack them together to the required amount (i.e. 3 Plinths high) and at both ends screw the Plinths together. With them as one unit it is much easier to handle and install.

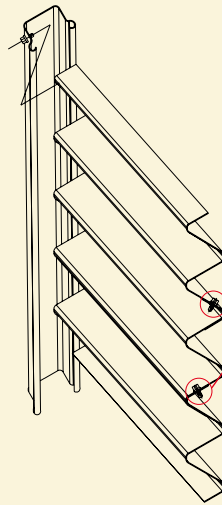

Note: GramLine Plinths have a small radius on one side and a slightly larger radius on the other side. The smaller radius always fits into the larger radius when stacking together.

Screw Plinths together at both ends where they overlap. These screws will be concealed inside the Channel Posts once installed.

KIT-GATE

- Decide on the width of Gate. To calculate the width of the gate you must deduct the width of the two gate post, hinge gap and the latch gap.
 - Cut top and bottom Rails to required length.
- Note:** Rail length will be less the two Gate Styles (100mm).
- Slide the Gate Strips on the edges of the Sheets.
 - Install top and bottom Rail onto sheets.
 - Slide Gate Style into Rail on one side, then into the other side.
 - Clamp the gate together and fix two self-drilling screws on all four corners front and back of gate.

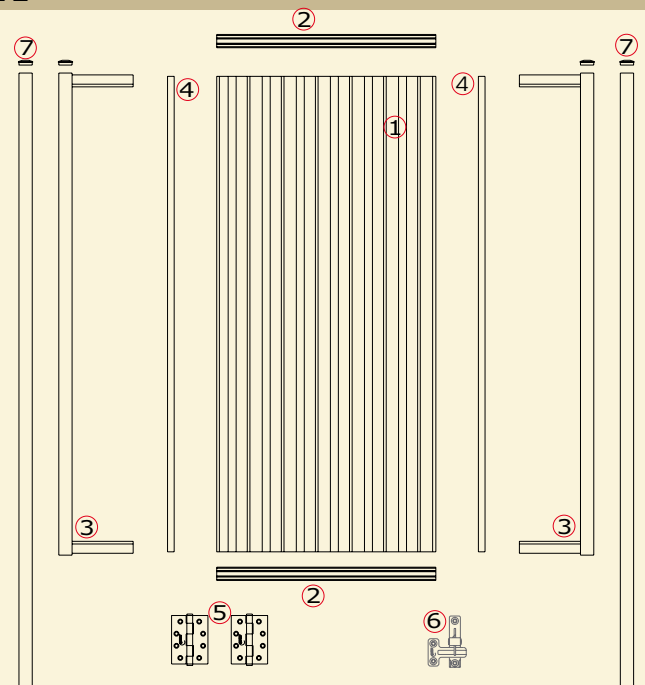
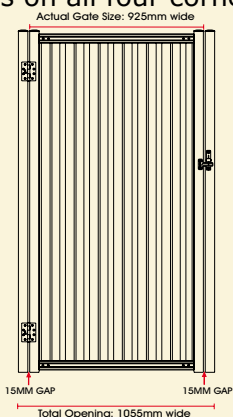

Components

- (1) 1 x Infill Sheet 820mm wide
- (2) 1 x Rail 2370mm wide
- (3) 2 x Gate Styles
- (4) 2 x Gate Strips
- (5) 2 x Stainless Steel Butt Hinges
- (6) 1 x Stainless Steel Long D'Latch
- (7) 2 x 50 Square Posts
- (8) 40 x Self Drilling Screws

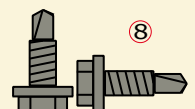

MAINTENANCE

TIPS ON HOW TO MAINTAIN YOUR GRAMLIN STEEL PRIVACY FENCE

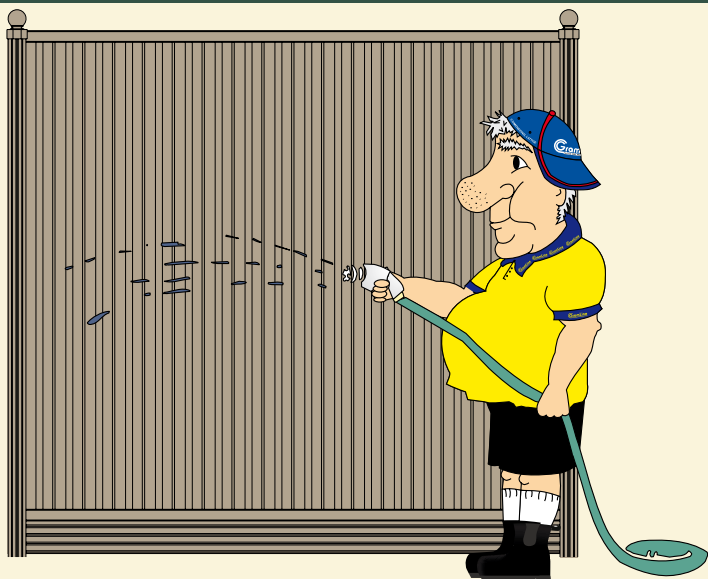

HOW TO KEEP YOUR FENCE LOOKING ITS BEST



- Don't allow a build up of soil, leaf litter or garden clippings in the bottom Rail of your Fence. This will inhibit water drainage.

- A GramLine Plinth should be used in this situation.

- Hose down your GramLine Steel Privacy Fence periodically.
- You can either wash your fence down with a bucket of water and a soft bristle broom, or a garden hose.
- **WARNING:** Check on your local water restrictions.
- Avoid spraying your fence with garden or pest control chemicals. Make sure you hose down the fence immediately should this occur.
- It is recommended you avoid abrasive cleaners.

TIPS IF YOU HAVE A PET DOG

- Dogs urine will reduce the life expectancy of your Steel Privacy Fence.
- If the dog constantly uses the same area, it will cause corrosion, to minimise the effect of this behaviour, hose down the area frequently.

HOW TO REMOVE COBWEBS

- A soft bristle broom can be used to remove cobwebs off your Steel Privacy Fence.

GRAFFITI ON FENCING

- Contact professional Graffiti removers.
- Replace damaged panels.

COASTAL REGION

- If your fence is located in a coastal region, a little extra maintenance is required.
- You should hose down your fence more frequently especially the under lying edges of your rails to remove salt build up (before proceeding check on local water restrictions).
- If your fence is located within the splash zone of your swimming pool, a little extra maintenance is required. You should hose down your fence more frequently.



16-22 Cullen Place, Smithfield NSW 2164
PO Box 6006, Wetherill Park NSW 2164
Australia

Telephone: +61 2 9757 1199 Fax: +61 2 9757 1296
Email: info@gram.com.au
Gram Engineering Pty Ltd t/as GramLine

ABN 35 002 193 311
www.gramline.com

Distributed by:



PLEASE NOTE: This brochure is correct at the time of printing and whilst we try to ensure our customers get the latest information, please check with your GramLine supplier or our Head Office for any updates or improvements. E&OE
For further advice and information on GramLine products and your nearest supplier/installer
please call Freecall 1800 GRAMLIN